



FACTORY DIRECT • SINCE 1991

PRICE LIST

APRIL 1, 2009





9405 Holly Street N.W. • Coon Rapids, MN 55433

Toll Free 800-234-1146 • Local 763-544-9348

Fax 763-544-6543

Web Site: www.northwestlightingsystems.com

E-mail: nwlighting@aol.com

• John Hannasch, Sales Manager

BALLAST, LAMPS, RETROFIT KITS

- High Pressure Sodium
- Mercury Vapor
- Metal Halide
- Fluorescent

SUPPLIER OF:

Hid Ballasts	Magnetic Fluorescent Ballasts	Sign Ballasts
Hid Lamps	Electronic Fluorescent Ballasts	Sign Lamps
F-Can Ballasts	Fluorescent Lamps	Circleline Ballasts
Postline Ballasts	Hid Fixtures	Circleline Lamps
Sockets	PL Lamps and Adapters	Ignitors - Standard and Specialty
Incandescent Lamps	Weather Proof Fuse Holders and Fuses	Exit Signs
MR-16	Halogen	Quartz LED

***Headquarters for all Easy and Hard-to-Find
Ballast and Lamps !!!***



TERMS AND CONDITIONS

PAYMENT TERMS

Cash, COD or Credit Card. Net terms for larger orders will be considered upon credit approval with a credit card backup.

FREIGHT TERMS

Ground freight will be prepaid on shipments within the United States, except to Alaska and Hawaii, for ballasts and HID lamps. Freight will be prepaid on shipments greater than \$2,500.00 for fluorescent lamps. All freight prepaid orders will carry a flat \$20.00 handling charge.

WARRANTY

Two years on magnetic ballasts.
Five years on electronic ballasts.

FOB POINT

Coon Rapids, MN

DROPSHIPS

Available upon request.

RETURNS

A return authorization must be received from our Customer Service Department prior to return of product. Defective product will be repaired or replaced at our discretion.

RESTOCKING CHARGE

25% on all returns of non-defective product.

CUSTOMER SERVICE HOURS

7:00 a.m. to 5:00 p.m. Central Time,
Monday through Friday.

CUSTOMER SERVICE CONTACTS

Kathi, Rick, John

PRICING

No Minimum order
Prices Subject to change without notice.



9405 Holly Street N.W. • Coon Rapids, MN 55433

HID BALLAST REPLACEMENT KITS

U.L. LISTED

H I G H P R E S S U R E S O D I U M

Watts	Volts	Part Number	Kit Price
35	120	BH 35/12-K	\$ 25.00
50	120	BH 50/12-K	\$ 26.00
70	120	BH 70/12-K	\$ 28.00
100	120	BH 100/12-K	\$ 30.00
150	120	BH 150/12-K	\$ 32.00
70	Quad	BH 70Q-K	\$ 41.00
100	Quad	BH 100Q-K	\$ 45.00
150	Quad	BH 150Q-K	\$ 53.00
200	Quad	BH 200Q-K	\$ 77.75
250	Quad	BH 250Q-K	\$ 72.00
250	480	BH 250/48-K	\$ 75.00
400	Quad	BH 400Q-K	\$ 75.00
400	480	BH 400/48-K	\$ 78.00
1000	Quad	BH 1000Q-K	\$ 130.00
1000	480	BH 1000/48-K	\$ 135.00

M E T A L H A L I D E

Watts	Volts	Part Number	Kit Price
50	Quad	BM50Q-K	\$ 49.00
70	Quad	BM70Q-K	\$ 51.00
100	Quad	BM100Q-K	\$ 54.00
150	Quad	BM150Q-K	\$ 59.00
175	Quad	BM175Q-K	\$ 39.95
250	Quad	BM250Q-K	\$ 54.90
250	480	BM250/48-K	\$ 58.90
400	Quad	BM400Q-K	\$ 64.90
400	480	BM400/48-K	\$ 67.80
1000	Quad	BM1000Q-K	\$ 89.00
1000	480	BM1000/48-K	\$ 91.00
1500	Quad	BM1500Q-K	\$ 125.00
1500	480	BM1500/48-K	\$ 130.00
400	5TAP	BM400/5TAP-K	\$ 80.00
1000	5TAP	BM1000/5TAP-K	\$ 118.00

Kits Include: • Ballast • Bracket • Capacitor/Ignitor (If required)



9405 Holly Street N.W. • Coon Rapids, MN 55433

LAMP PRICES

M E T A L H A L I D E		
Watts	NLSC P/N	Price
50	MH50/U/MED	\$ 19.00
70	MH70/U/MED	\$ 18.00
100	MH100/U/MED	\$ 18.00
150	MH150/U/MED	\$ 24.00
175	MH175/U/MED	\$ 18.00
175	MH175/U	\$ 15.00
250	MH250/U	\$ 15.00
400	MH400/U	\$ 15.00
400	MH400/U/ED28	\$ 25.00
1000	MH1000/U	\$ 27.00
1000	MH1000/U/BT37	\$ 35.00
1500	MH1500/U	\$ 39.00

H I G H P R E S S U R E S O D I U M		
Watts	NLSC P/N	Price
35	LU35MED	\$ 15.00
50	LU50MED	\$ 15.00
70	LU70MED	\$ 15.00
100	LU100MED	\$ 15.00
150	LU150MED	\$ 15.00
50	LU50	\$ 15.00
70	LU70	\$ 15.00
100	LU100	\$ 15.00
150	LU150	\$ 15.00
200	LU200	\$ 15.00
250	LU250	\$ 15.00
400	LU400	\$ 15.00
1000	LU1000	\$ 39.00

- Specialty lamps also available, call for pricing.

METAL HALIDE PULSE START KITS

Kits Include:

- Ballast
- Capacitor
- Starter
- Bracket

Part Number	Types of Ballast	Kit Price
BM175Q-K/PS	175W-Quad	\$ 52.00
BM200Q-K/PS	200W-Quad	\$ 56.40
BM250Q-K/PS	250W-Quad	\$ 67.75
BM250/48-K/PS	250W-480V	\$ 68.90
BM320Q-K/PS	320W-Quad	\$ 69.00
BM320/48-K/PS	320W-480V	\$ 69.00
BM400Q-K/PS	400W-Quad	\$ 79.00
BM400/48-K/PS	400W-480V	\$ 79.00
BM450Q-K/PS	450W-Quad	\$ 98.00
BM750Q-K/PS	750W-Quad	\$ 121.00
BM1000Q-K/PS	1000W-Quad	\$ 116.00
BM1000/48-K/PS	1000W-480V	\$ 116.00

- Quad Voltages 120V/208V/240V/277V -

METAL HALIDE PULSE START LAMPS (Vertical, Horizontal or Universal Burn)

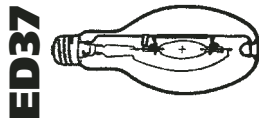

ED37
Dia. = 4 5/8" (120 mm)
MOL = 11 1/2" (292 mm)
LCL = 7" (178 mm)
Base = E39

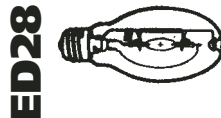

ED28
Dia. = 3 1/2" (90 mm)
MOL = 8 5/16" (211 mm)
LCL = 5" (127 mm)
Base = E39

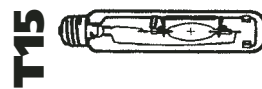

T15
Dia. = 1 7/8" (46 mm)
MOL = 11 1/2" (292 mm)
LCL = 7" (178 mm)
Base = E39

Part Number	Standard Lamp Price
MS175/PS	\$ 38.00
MS200/PS	\$ 38.00
MS250/PS	\$ 38.00
MS320/PS	\$ 29.00
MS350/PS	\$ 38.00
MS400/PS	\$ 38.00
MS450/PS	\$ 39.00
MS750/PS	\$ 49.00
MS1000/PS	\$ 59.00

• Consult the factory for open fixture rated lamps

Hi-Bay Fixture T8 Fluorescent 4 and 6-Lamp



FEATURES & SPECIFICATIONS

Attributes

- New Engineered Lighting design features precision formed beveled G320 reflector to achieve maximum light output.
- Delivers either 15,000 lumens from four 32-watt T8 lamps or 23,000 lumens from six lamps. Replaces H.I.D. fixtures on a one-for-one basis.
- Instant on. Unlike most H.I.D. fixtures.
- Optional heavy duty 6ga wire guard or
- Clear lens cover for lamp protection.

Ballast Access Doors

Top side Hinged Panel Doors flip open with surface mounted ballast for easy, in your face, Terminal Block connections

Ballast

High Lumen .99 power factor, Electronic T8 Ballast with 1.15 Ballast factor, Class P, outdoor type 1, 2 ballast for 2 stage control

Lampholders

Snap lock sockets for F32T8 lamps rated 110C, 600volt

Mounting

Fixtures designed for Chain, Grippler, Pendant, or Stem mounting

Housing

Die formed heavy gauge cold rolled steel. 8 preformed shark slot 8fin air vents for air flow. Prepunched slot mounting holes for chain mtg. Prepunched mounting holes for Grippler type double toggle Y-Fit hanger cable.

Finish

Industrial Powder Coated White Housing

Reflector

Precision formed Harden Alanod Aluminum G320 High Lumen Specular, GMBH certified

Listing

Fixtures conform to Underwriters Laboratories Standards for production are carefully tested.

Models: FX-4L32T8 - UNIV
FX-6L32T8 - UNIV-HB - \$ 98.00

For Optimum Scotopic Performance Use T8 800 series 5000K lamps

Call 1-800-234-1146 For Immediate Delivery

Email: nwlighting@aol.com www.northwestlightingsystems.com



9405 Holly Street N.W. • Coon Rapids, MN 55433

**Having trouble finding or affording postline ballasts?
The government has banned the sale of mercury vapor ballasts.**

NORTHWEST LIGHTING HAS THE ANSWER

**105 WATT SELF BALLASTED COMPACT FLUORESCENT LAMPS.
AS EASY AS DISCONNECTING
THE EXISTING BALLAST AND SCREWING IN A NEW LAMP
AVAILABLE IN MEDIUM OR MOGUL BASE
120 VOLT 41K OR 277 VOLT MOGUL BASE 41K**

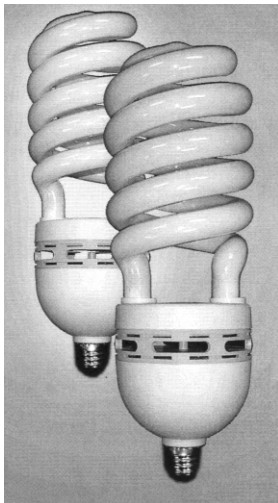

Item Description:

105W 120V Spiral 4100K Medium Base - \$29.50
85W 120V Med Base at 5500 Lumens - \$24.75

General

Lamp No	SP105/41MED also available in 5K
Bar Code	81184
Volts	120
Watts	105
MOL in/mm	11.5/292
MOD in/mm	4.41/112
Avg Life	8000
Base	Medium Screw (E26)
Special Desc	Recommended temperature range -10°C (14°F) to +40°C (104°F)
CT deg K	4100
Replaces	Std 500W Incandescent
CRI	82
Approx Initial Lumens	6900 * 175 Watt MV = 6800

Toll Free 1-800-234-1146



9405 Holly Street N.W. • Coon Rapids, MN 55433

F - C A N S

ITEM ID	Item Description	Price
FCAN100WHPS	100W HPS F-CAN 120/277V	70.00
FCAN100WMH	100W MH F-CAN 120/277V	70.00
FCAN150WHPS	150W HPS F-CAN120/277V	90.00
FCAN150WMH	150W MH F-CAN 120/277V	93.00
FCAN175WMH	175W MH F-CAN 120/277V	78.00
FCAN250WMH	250W MH F-CAN 120/277V	93.00
FCAN400WMH	400W MH F-CAN 120/277V	123.00
FCAN50WMH	50W MH F-CAN 120/277V	51.00
FCAN70WHPS	70W HPS F-CAN 120/277V	63.00
FCAN70WMH	70W MH F-CAN 120/277V	73.00

S I G N B A L L A S T S

ITEM ID	Item Description	Price
SIGN0412-12	1-2L 4-12FT 120V BALLAST	50.50
SIGN0620-24	2-4L 6-20FT 120V BALLAST	64.50
SIGN1224-24	2-4L 12-24FT 120V BALLAST	77.35
SIGN1240-46	4-6L 12-40FT 120V BALLAST	104.60
SIGN2040-24	2-4L 20-40FT 120V BALLAST	104.60
SIGN2448-46	4-6L 24-48FT 120V BALLAST	117.50

• Call for electronic or 277 volt sign ballasts.

I G N I T O R S

S55V	35-150 WATT HPS	\$ 15.00
S100V	200-400 WATT HPS	\$ 16.00
S250V	1000 WATT HPS	\$ 20.00
SMH-2	35-450 WMH	\$ 15.00
FS-2	Flourescent Starter	\$.59

HID CAPACITORS (Oil or Dry Caps)

H I G H I N T E N S I T Y D I S C H A R G E

In Stock Items \$12.00

PRECISION PHOTOCONTROLS

Part Number	Volt	Price
A-105	120V Button	\$ 6.60
ST-15	120V Swivel	\$ 9.20
ST-168	208-277V Swivel	\$ 11.00
P2275	120V Twist Lock	\$ 6.60
A-1068	208-277V Button	\$ 9.10
T-15	120V Stationary	\$ 9.20
ECDV-AP-TD	105-285V Twist Lock	\$ 9.00
T-168	208/277 Stationary	\$ 9.50
JP-275	Shorting Cap	\$ 4.50
M2A	Twist Lock Mounting	\$ 10.50
P7275	480V Twist Lock	\$ 14.15
ST-19	480V Stationary	\$ 19.50
T-30	3KVA Stationary 120V	\$ 18.25
T-368	3KVA 208/277V Stationary	\$ 22.50
Esc-124DS	Photocell/Timer 105/285V	\$ 24.50

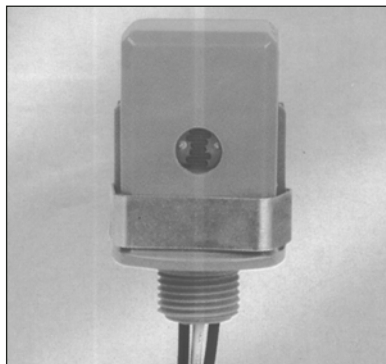

T-Series

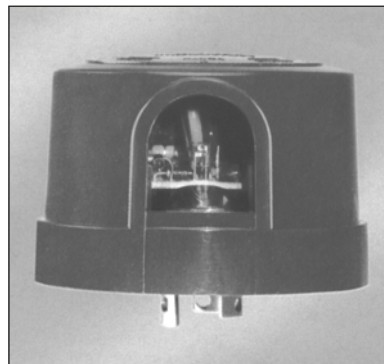

Twist Lock

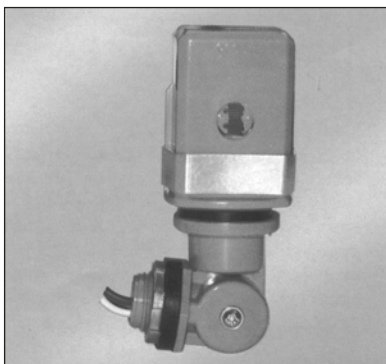

Swivel Series

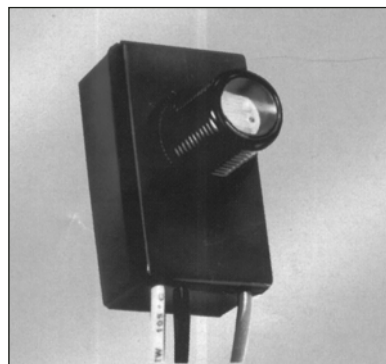

A-Button Type



Photocell/Timer



9405 Holly Street N.W. • Coon Rapids, MN 55433

FLUORESCENT BALLASTS AND LAMPS

Item Description	Volts	Part Number	Price
(1/2) 13W QUAD 4 PIN	108-305	NM213UNIVKIT	\$ 25.30
(1/2) 18W QUAD 4 PIN	108-305	NM218UNIVKIT	\$ 25.30
(1/2) 26W QUAD 4 PIN	108-305	NM2642UNIVKIT	\$ 25.30
(1/2) 42W 4 PIN	120/277	NM242UNIVKIT	\$ 38.50
(1/2) 24/39W T5 HO	120/277	NM244/39-UNV	\$ 31.50
(1/2) 54W T5 HO	120/277	NM254-UNV	\$ 35.75
(3/4) 54W T5 HO	120/277	NM454-UNV	\$ 49.00

E L E C T R O N I C

Part Number	Volts	Part Number	Price
NM32-2-UNIV-T8	120/277	1/2L T8 UNIV BALLAST	\$ 14.95
NM32-3-UNIV-T8	120/277	2/3L T8 UNIV BALLAST	\$ 17.00
NM32-4-UNIV-T8	120/277	3/4L T8 UNIV BALLAST	\$ 18.00
NM96-120/EL	120	1/2L F96T12 120V ELECTRONIC	\$ 19.00
NM96-277/EL	277	1/2L F96T12 277V ELECTRONIC	\$ 19.00
NM96-120HO/EL	120	1/2L F48 THRU F96 T12 HO	\$ 32.95
NM96-277HO/EL	277	1/2L F48 THRU F96 T12 HO	\$ 32.95
NM96-UNIVHO/EL	120/277	1/2L F48 THRU F96 T12 HO	\$ 34.95
NM40-120/EL	120	1/2L F34/40 T12 ELECTRONIC	\$ 14.25
NM40-277/EL	277	1/2L F34/40 T12 ELECTRONIC	\$ 14.25
LPO2/32-T8-UNIV	120/277	1 OR 2 F32T8 120/277V (low power factor)	\$ 17.95
LPO4/32-T8-UNIV	120/277	3 OR 4 F32T8 120/277V (low power factor)	\$ 21.00
NM96-T8-UNIV	120/277	1/2L F96T8 UNIV	\$ 25.00
NM96-T8/HO-120V	120	1/2L F48/60/72/96 T8HO 120V	\$ 49.75

- Also available 2 and 4 pin compact fluorescent ballasts.
Call for pricing

L E D

Item ID	Item Description (Various Colors)	Call for Pricing
LED/C7	C7 CANDELABRA BASE	
LED/C9	C9 INTERMEDIATE BASE	
LED/G20	G20 CANDELABRA BASE	
LED/G30	G30 INTERMEDIATE BASE	
LED/G12.5	G12.5 MEDIUM BASE	
LED/S14	S14 MEDIUM BASE	
LED/STRINGER	36 LEDS and 70 LED STRINGER LIGHTS	
LED/PAR	PAR 20/30 and 38 FLOODS	
LED/MR16	MR16 12V/24V/120V	

R E T R O B R A C K E T S

STILL USING F96T12 LAMP'S?

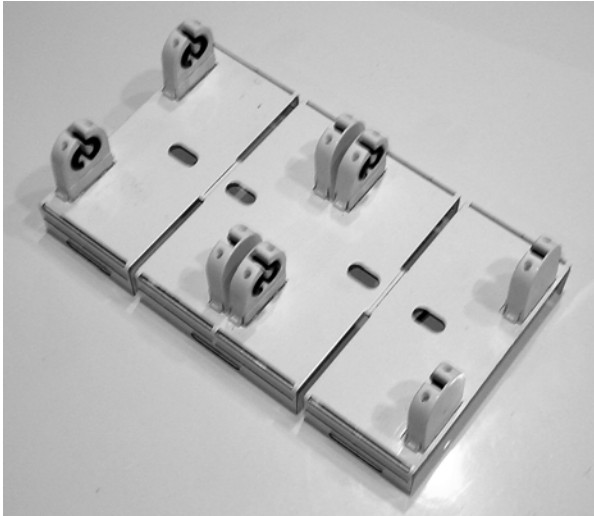

It's time to convert them to the more energy efficient F32T8 lamp's.

Using this conversion bracket, convert your 2 lamp 8 foot T12 fixture to a 4 lamp 4 foot T8 fixture and save about 30 watts per fixture.

It's easy, the socket's are already installed.

Bracket set \$12.00 each

4 Lamp Ballast \$18.00 each

Ask for the 10% discount when ordered together!

N E W L E D D O W N L I G H T T R I M

4" AND 6" LED DOWN LIGHT TRIMS

- **584lm @ 3500K, 502lm @ 2700K**
 - *Compare to a 65W BR30*
- **UL Classified for Progress & Competitive Cans**
 - *Ideal for Remodel 9 (see spec. sheets)*
- **High Efficiency Regressed Optics**
 - *Excellent Glare Control*
- **Approved for Use in Wet Locations**
 - *Can Use Throughout the Site*
- **High Efficiency Lens Diffuses LED Images**
 - *A Single Visible Source of Light*
- **50K Hours Life (70% Lumen Maintenance)**
 - *20-30 Years Under Normal Household Use*
- **Metal Flange Integral to Lower Reflector**
 - *Clean Aesthetics*

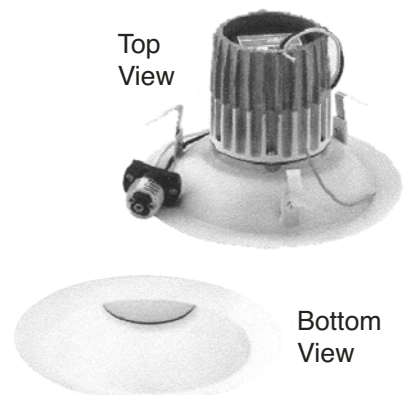



9405 Holly Street N.W. • Coon Rapids, MN 55433

COMPACT FLUORESCENTS

TWIN AND QUAD CFL'S

Watts	Kelvin	Average Life	Price
5, 7, 9 or 13W twin 2 pin	27, 35, 41, 50, 65 K	10,000	\$ 2.55
13 watt quad 2 pin	27, 35, 41, 50, 65 K	10,000	\$ 2.55
13 watt quad 4 pin	27, 35, 41, 50, 65 K	10,000	\$ 3.25
18 watt quad 2 pin	27, 35, 41, 50, 65 K	10,000	\$ 3.55
18 watt quad 4 pin	27, 35, 41, 50, 65 K	10,000	\$ 3.55
26 watt quad 2 pin	27, 35, 41, 50, 65 K	10,000	\$ 3.95
26 watt quad 4 pin	27, 35, 41, 50, 65 K	10,000	\$ 3.95

INTEGRAL SPIRALS

Watts	Kelvin	Average Life	Price
4 watt Mini Spiral	27 K		\$ 9.00
13 watt Mini Spiral	27/35/41/5 K	8,000 to 10,000	\$ 3.95
19 watt Mini Spiral	27/35/41/5 K	8,000 to 10,000	\$ 4.50
23 watt Mini Spiral	27/35/41/5 K	8,000 to 10,000	\$ 4.75
32 watt Mini Spiral	27/35/41/5 K	8,000 to 10,000	\$ 5.95
42 watt Mini Spiral	27/35/41/5 K	8,000 to 10,000	\$ 9.95

LARGE SPIRALS

Watts	Kelvin	Average Life	Price
65 watt	27, 5 K	8,000	\$ 24.75
85 watt	41, 50 K	8,000	\$ 24.75
105 watt	41, 50 K	8,000	\$ 29.50

GLOBE TYPE CFL'S

Watts	Kelvin	Average Life	Price
15 watt	3 K	8,000	\$ 6.95
13 watt A19	3 K	8,000	\$ 6.85

REFLECTOR CFL'S (1 piece) FROSTED

Watts	Kelvin	Average Life	Price
15 watt R20	65 K		\$ 9.95
15 watt R30	27/41/5/65 K	8,000	\$ 9.50
16 watt R30 Dimmable	27 K	10000	16.95
20 watt R30	27/41/5/65 K	8,000	\$ 9.75
23 watt R40	27/41/5/65 K	8,000	\$ 9.95

• Triple tube and PL-L lamps also available.

FULHAM WORKHORSES

Item ID	Price	Item ID	Price
WH1-120-L	\$ 19.75	WH3-277-BLS	\$ 21.95
WH1-277-L	\$ 19.75	WH3-277-C	\$ 21.95
WH2-120-C	\$ 20.75	WH3-277-L	\$ 21.95
WH2-120-C-BLS	\$ 20.75	WH33-120-BLS	\$ 21.95
WH2-120-L	\$ 20.75	WH33-120-L	\$ 21.95
WH2-277-BLS	\$ 20.75	WH4-120-L	\$ 22.95
WH2-277-C	\$ 20.75	WH4-277-L	\$ 22.95
WH2-277-L	\$ 20.75	WH5-120-L	\$ 26.95
WH22-120	\$ 20.75	WH5-277-L	\$ 26.95
WH22-120-C	\$ 20.75	WH6-120-L	\$ 27.95
WH22-277-L	\$ 20.75	WH6-277-L	\$ 27.95
WH3-120-BLS	\$ 21.95	WH7-120-L	\$ 45.00
WH3-120-C	\$ 21.95	WH7-277-L	\$ 45.00
WH3-120-L	\$ 21.95	WH8-120-L	\$ 45.00
		WH8-277-L	\$ 45.00

10 BALLASTS
OPERATE
132 LAMPS
IN
860 COMBINATIONS

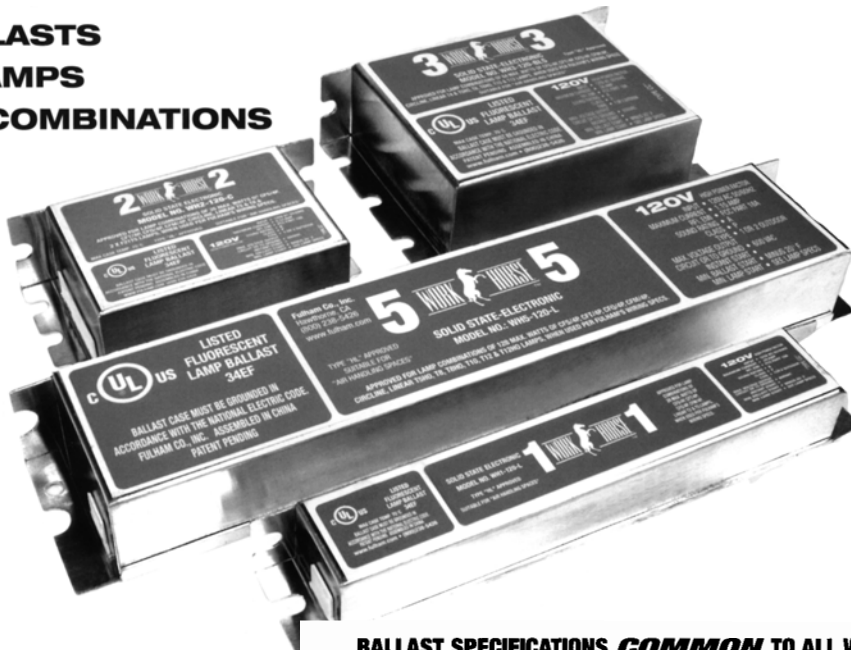

BALLAST SPECIFICATIONS *COMMON TO ALL WORKHORSE*

Operating Voltage:	120 VAC ± 10% 277 VAC ± 10%	Regulatory Approvals:	UL & cUL Listed Type 1 Outdoors
Frequency:	50/60 Hz	High Power Factor:	> .90
ATHD:	Meets ANSI C82.11-1993	Open Circuit Voltage:	600 V RMS Max.
Protection/Input:		Ballast Min. Operating Temp.:	-20° F (-30° C)
Over Current:	Fuse	Ballast Maximum Case Temp.:	158° F (70° C)
Voltage Transients:	MOV (PER ANSI C82.11 – 1993)	Ballast Lamp Starting Mode:	Instant Start
EMI: FCC CFR Title 47	Part 18 non-consumer	Class P Inherent Thermal Protection	
Protection/Output:		Sound Rating - A	
Open/Shorted Lamp			

SOCKETS
F L U O R E S C E N T H I G H O U T P U T



FE30-1



FE30-2

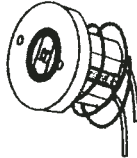

FE82



FE83

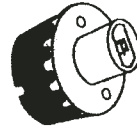

FE523

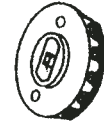

FE524

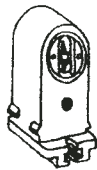

FE700



FE701



FE13550



FE13551

- For HO and VHO lamps
- 10 per box

• HO Socket Now Just \$2.95 !!!

M O G U L A N D M E D I U M B A S E

Part Number	Rating	Price
SOCKETMED	Pulse Rated 4KV Medium	\$ 8.00
SOCKETMOG	Pulse Rated 5KV Mogul	\$ 10.00
SOCKETMOG/O	Pulse Rated 5KV Open Mogul Fixture	\$ 12.00
SOCKETMR16	MR16 Gx5.3 Base	\$ 3.60
SOCKETLPS	Low Pressure Sodium	\$ 26.00
SOCKETCAND	Candelabra Base	\$ 5.00
MOG/MED/REDUCER	Mogul to Medium Reducer	\$ 8.00



9405 Holly Street N.W. • Coon Rapids, MN 55433

Toll Free 800-234-1146 • Locally 763-544-9348 • Fax 763-544-6543